



White-WH



Pearl-PR



Beige-BG



Gold-GD



Copper-CP



Sliver-SV



Gray-GR



Black-BK



DATASHEET

Item No.:B1111/B1112/B1103

Product Image

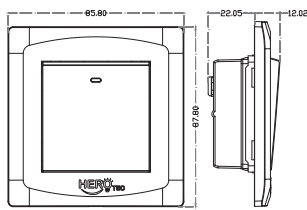

Name: 1GANG 1WAY/2WAY PLATE SWITCH

Color: White,Black,Pearl,Gold, Gray,Beige,Copper,Sliver

Dimensions: L:85.8mm W:87.8mm H:34.07mm

Socket poles: Double poles

Current Rating: 16AX

Voltage: 220-250V~

Maximum Load: 16 Amp

Working Temperature: -20°C to +40°C

Standard: IEC60669

DATASHEET

Item No.:B1121/B1122

Product Image

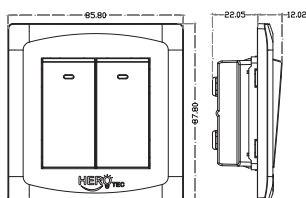

Name: 2GANG 1WAY/2WAY PLATE SWITCH

Color: White,Black,Pearl,Gold, Gray,Beige,Copper,Sliver

Dimensions: L:85.8mm W:87.8mm H:34.07mm

Socket poles: Double poles

Current Rating: 16AX

Voltage: 220-250V~

Maximum Load: 16 Amp

Working Temperature: -20°C to +40°C

Standard: IEC60669

DATASHEET

Item No.:B1131/B1132

Product Image

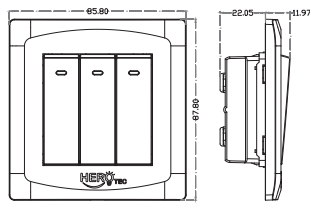

Name: 3GANG 1WAY/2WAY PLATE SWITCH

Color: White,Black,Pearl,Gold,
Gray,Beige,Copper,Sliver

Dimensions: L:85.8mm W:87.8mm H:34.02mm

Socket poles: Double poles

Current Rating: 16AX

Voltage: 220-250V~

Maximum Load: 16 Amp

Working Temperature: -20°C to +40°C

Standard: IEC60669

DATASHEET

Item No.:B1141/B1142

Product Image

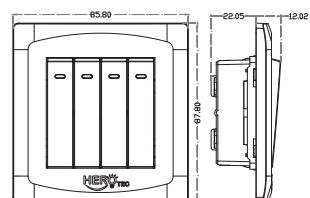

Name: 4GANG 1WAY/2WAY PLATE SWITCH

Color: White,Black,Pearl,Gold,
Gray,Beige,Copper,Sliver

Dimensions: L:85.8mm W:87.8mm H:34.07mm

Socket poles: Double poles

Current Rating: 16AX

Voltage: 220-250V~

Maximum Load: 16 Amp

Working Temperature: -20°C to +40°C

Standard: IEC60669

DATASHEET

Item No.:B1117

Product Image

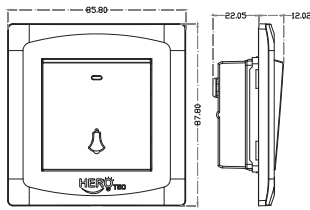

Name:	BELL SWITCH
Color:	White,Black,Pearl,Gold, Gray,Beige,Copper,Sliver
Dimensions:	L:85.8mm W:87.8mm H:34.07mm
Socket poles:	Double poles
Current Rating:	16AX
Voltage:	220-250V~
Maximum Load:	16 Amp
Working Temperature:	-20°C to +40°C
Standard:	IEC60669

DATASHEET

Item No.:B1146

Product Image

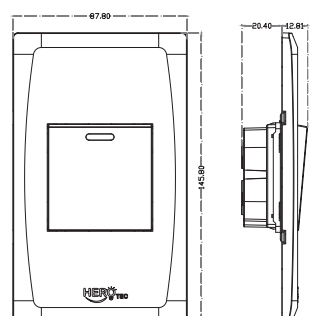

Name:	45A switch with neon
Color:	White,Black,Pearl,Gold, Gray,Beige,Copper,Sliver
Dimensions:	L:87.8mm W:145.8mm H:33.2mm
Socket poles:	Double poles
Current Rating:	45AX
Voltage:	220-250V~
Maximum Load:	45 Amp
Working Temperature:	-20°C to +40°C
Standard:	IEC60669

DATASHEET

Item No.:B1120

Product Image

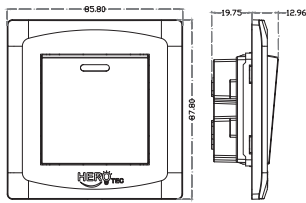

Name:	20A switch with neon
Color:	White,Black,Pearl,Gold, Gray,Beige,Copper,Sliver
Dimensions:	L:85.8mm W:87.8mm H:32.71mm
Socket poles:	Double poles
Current Rating:	20AX
Voltage:	220-250V~
Maximum Load:	20 Amp
Working Temperature:	-20°C to +40°C
Standard:	IEC60669

DATASHEET

Item No.:B1145

Product Image

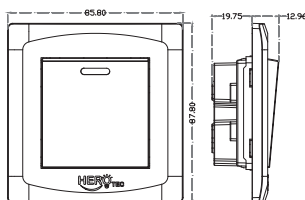

Name:	45A switch with neon
Color:	White,Black,Pearl,Gold, Gray,Beige,Copper,Sliver
Dimensions:	L:85.8mm W:87.8mm H:32.71mm
Socket poles:	Double poles
Current Rating:	45AX
Voltage:	220-250V~
Maximum Load:	45 Amp
Working Temperature:	-20°C to +40°C
Standard:	IEC60669

DATASHEET

Item No.:B1113A

Product Image

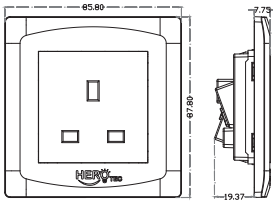

Name:	13A 1 gang socket
Color:	White,Black,Pearl,Gold, Gray,Beige,Copper,Sliver
Dimensions:	L:85.8mm W:87.8mm H:27.12mm
Socket poles:	Double poles
Current Rating:	13AX
Voltage:	220-250V~
Maximum Load:	13 Amp
Working Temperature:	-20°C to +40°C
Standard:	BS1363

DATASHEET

Item No.:B1113D

Product Image

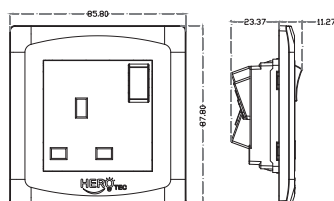

Name:	13A 1 gang switched socket DP
Color:	White,Black,Pearl,Gold, Gray,Beige,Copper,Sliver
Dimensions:	L:85.8mm W:87.8mm H:34.64mm
Socket poles:	Double poles
Current Rating:	13AX
Voltage:	220-250V~
Maximum Load:	13 Amp
Working Temperature:	-20°C to +40°C
Standard:	BS1363

DATASHEET

Item No.:B1113E

Product Image

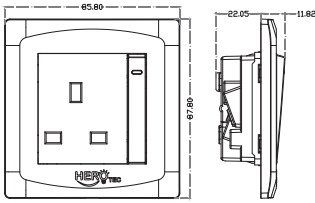

Name:	13A British Switched socket with neon
Color:	White,Black,Pearl,Gold, Gray,Beige,Copper,Sliver
Dimensions:	L:85.8mm W:87.8mm H:33.87mm
Socket poles:	Double poles
Current Rating:	13AX
Voltage:	220-250V~
Maximum Load:	13 Amp
Working Temperature:	-20°C to +40°C
Standard:	BS1363

DATASHEET

Item No.:B1113DL

Product Image

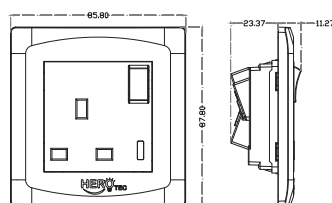

Name:	13A British Switched socket with neon
Color:	White,Black,Pearl,Gold, Gray,Beige,Copper,Sliver
Dimensions:	L:85.8mm W:87.8mm H:34.64mm
Socket poles:	Double poles
Current Rating:	13AX
Voltage:	220-250V~
Maximum Load:	13 Amp
Working Temperature:	-20°C to +40°C
Standard:	BS1363

DATASHEET

Item No.:B1113DTC

Product Image

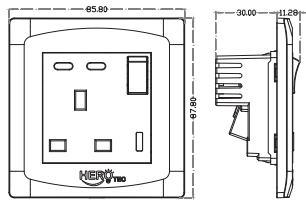

Name: 13A 1 gang switched socket DP+2 Type C

Color: White,Black,Pearl,Gold, Gray,Beige,Copper,Sliver

Dimensions: L:85.8mm W:87.8mm H:41.28mm

Socket poles: Double poles

Current Rating: 13AX

Voltage: 220-250V~

Maximum Load: 13 Amp

Working Temperature: -20°C to +40°C

Standard: BS1363

DATASHEET

Item No.:B1113ATC

Product Image

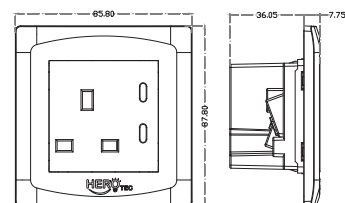

Name: 3 pin with 2 Type C

Color: White,Black,Pearl,Gold, Gray,Beige,Copper,Sliver

Dimensions: L:85.8mm W:87.8mm H:43.8mm

Socket poles: Double poles

Current Rating: 13AX

Voltage: 220-250V~

Maximum Load: 13 Amp

Working Temperature: -20°C to +40°C

Standard: BS1363

DATASHEET

Item No.:B114TC

Product Image

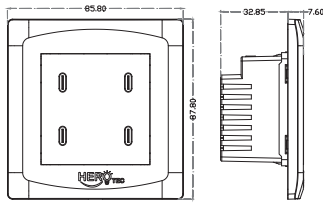

Name: 4 type C socket

Color: White,Black,Pearl,Gold, Gray,Beige,Copper,Sliver

Dimensions: L:85.8mm W:87.8mm H:40.45mm

Socket poles: Double poles

Current Rating: 13AX

Voltage: 220-250V~

Maximum Load: 13 Amp

Working Temperature: -20°C to +40°C

Standard: BS1363

DATASHEET

Item No.:B1140A

Product Image

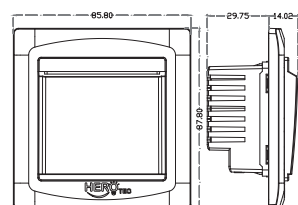

Name: 40A insert card for power

Color: White,Black,Pearl,Gold, Gray,Beige,Copper,Sliver

Dimensions: L:85.8mm W:87.8mm H:43.77mm

Socket poles:

Current Rating: 40AX

Voltage: 220V~

Maximum Load: 40 Amp

Working Temperature: -20°C to +40°C

Standard:

DATASHEET

Item No.:B1151

Product Image

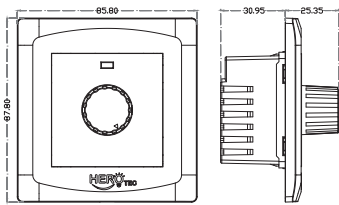

Name: 1 gang 400W speed switch printing fan pic

Color: White,Black,Pearl,Gold, Gray,Beige,Copper,Sliver

Dimensions: L:85.8mm W:87.8mm H:56.3mm

Socket poles: Double poles

Current Rating:

Voltage: 180-250V~

Maximum Load:

Working Temperature: -20°C to +40°C

Standard: IEC60669

DATASHEET

Item No.:B11500W

Product Image

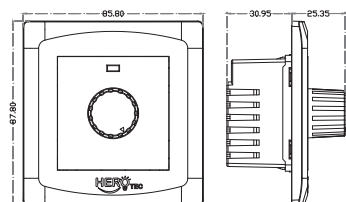

Name: light dimmer switch

Color: White,Black,Pearl,Gold, Gray,Beige,Copper,Sliver

Dimensions: L:85.8mm W:87.8mm H:56.3mm

Socket poles:

Current Rating:

Voltage: 180-250V~

Maximum Load:

Working Temperature: -20°C to +40°C

Standard: IEC60669

DATASHEET

Item No.:B1151E

Product Image

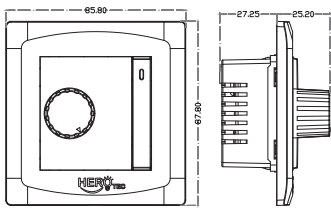

Name: Dimmer with one gang one way

Color: White,Black,Pearl,Gold, Gray,Beige,Copper,Sliver

Dimensions: L:85.8mm W:87.8mm H:52.45mm

Socket poles:

Current Rating:

Voltage: 220-250V~

Maximum Load:

Working Temperature: -20°C to +40°C

Standard: IEC60669

DATASHEET

Item No.:B1145S

Product Image

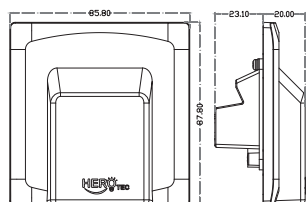

Name: 45A socket technical connector

Color: White,Black,Pearl,Gold, Gray,Beige,Copper,Sliver

Dimensions: L:85.8mm W:87.8mm H:43.1mm

Socket poles: Double poles

Current Rating: 45AX

Voltage: 220-250V~

Maximum Load: 45Amp

Working Temperature: -20°C to +40°C

Standard: BS1363

DATASHEET

Item No.:B11213DL

Product Image

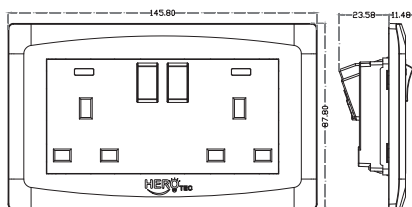

Name: Double switched socket with neon

Color: White,Black,Pearl,Gold, Gray,Beige,Copper,Sliver

Dimensions: L:145.8mm W:87.8mm H:35.06mm

Socket poles: Double poles

Current Rating: 13AX

Voltage: 220-250V~

Maximum Load: 13 Amp

Working Temperature: -20°C to +40°C

Standard: BS1363

DATASHEET

Item No.:B11213D

Product Image

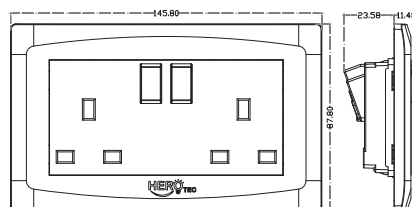

Name: 13A 2 gang switched socket DP

Color: White,Black,Pearl,Gold, Gray,Beige,Copper,Sliver

Dimensions: L:145.8mm W:87.8mm H:35.06mm

Socket poles: Double poles

Current Rating: 13AX

Voltage: 220-250V~

Maximum Load: 13Amp

Working Temperature: -20°C to +40°C

Standard: BS1363

DATASHEET

Item No.:B11213DLTC

Product Image

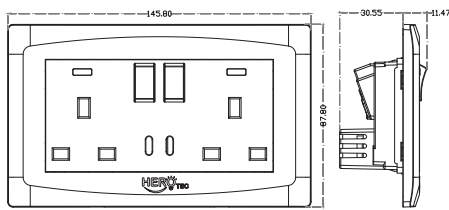

Name: 2*13A socket with 2 type C

Color: White,Black,Pearl,Gold, Gray,Beige,Copper,Sliver

Dimensions: L:145.8mm W:87.8mm H:42.02mm

Socket poles: Double poles

Current Rating: 13AX

Voltage: 220-250V~

Maximum Load: 13 Amp

Working Temperature: -20°C to +40°C

Standard: BS1363

DATASHEET

Item No.:B1145A13

Product Image

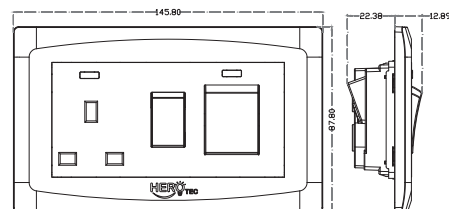
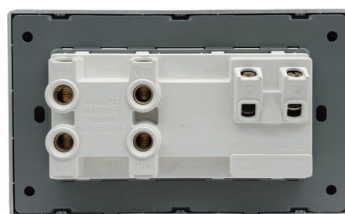

Name: Kitchen switch socket

Color: White,Black,Pearl,Gold, Gray,Beige,Copper,Sliver

Dimensions: L:145.8mm W:87.8mm H:35.27mm

Socket poles: Double poles

Current Rating: 13AX

Voltage: 220-250V~

Maximum Load: 13Amp

Working Temperature: -20°C to +40°C

Standard: BS1363

DATASHEET

Item No.:B1168

Product Image

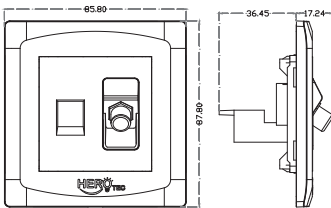

Name: satellite socket +telephone socket

Color: White,Black,Pearl,Gold,
Gray,Beige,Copper,Sliver
Dimensions: L:85.8mm W:87.8mm H:53.69mm

Socket poles:

Current Rating:

Voltage: 220-250V~

Maximum Load:

Working Temperature: -20°C to +40°C

Standard: BS5733

DATASHEET

Item No.:B1163A

Product Image

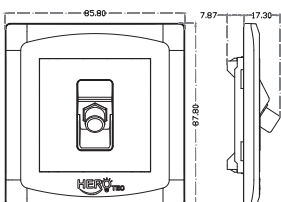

Name: SATTELITE SOCKET

Color: White,Black,Pearl,Gold,
Gray,Beige,Copper,Sliver
Dimensions: L:85.8mm W:87.8mm H:25.17mm

Socket poles: Double poles

Current Rating:

Voltage: 220-250V~

Maximum Load:

Working Temperature: -20°C to +40°C

Standard: BS5733

DATASHEET

Item No.:B1162-6

Product Image

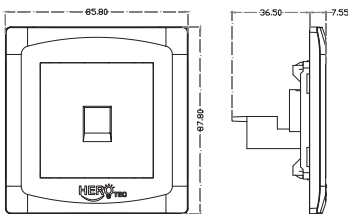

Name: computer socket (CAT6)

Color: White,Black,Pearl,Gold, Gray,Beige,Copper,Sliver

Dimensions: L:85.8mm W:87.8mm H:44.05mm

Socket poles:

Current Rating:

Voltage: 220-250V~

Maximum Load:

Working Temperature: -20°C to +40°C

Standard: BS5733

DATASHEET

Item No.:B1161

Product Image

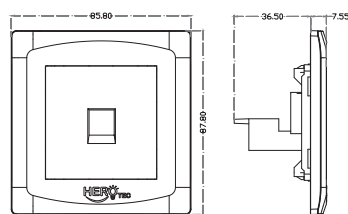

Name: TEL socket

Color: White,Black,Pearl,Gold, Gray,Beige,Copper,Sliver

Dimensions: L:85.8mm W:87.8mm H:44.05mm

Socket poles: Double poles

Current Rating:

Voltage: 220-250V~

Maximum Load:

Working Temperature: -20°C to +40°C

Standard: BS5733

DATASHEET

Item No.:B1164-6

Product Image

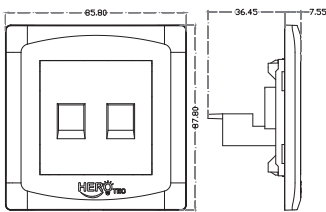

Name: TEL+computer socket

Color: White,Black,Pearl,Gold, Gray,Beige,Copper,Sliver

Dimensions: L:85.8mm W:87.8mm H:44mm

Socket poles:

Current Rating:

Voltage: 220-250V~

Maximum Load:

Working Temperature: -20°C to +40°C

Standard: BS5733

DATASHEET

Item No.:B11261

Product Image

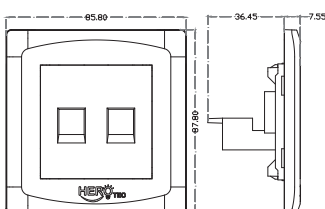

Name: 2 TEL socket

Color: White,Black,Pearl,Gold, Gray,Beige,Copper,Sliver

Dimensions: L:85.8mm W:87.8mm H:44mm

Socket poles: Double poles

Current Rating:

Voltage: 220-250V~

Maximum Load:

Working Temperature: -20°C to +40°C

Standard: BS5733

DATASHEET

Item No.:B11262-6

Product Image

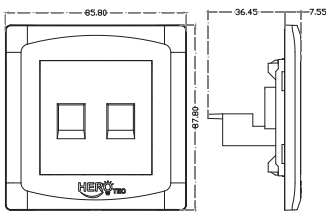

Name: 2 gang computer socket (CAT6)

Color: White,Black,Pearl,Gold, Gray,Beige,Copper,Sliver

Dimensions: L:85.8mm W:87.8mm H:44mm

Socket poles:

Current Rating:

Voltage: 220-250V~

Maximum Load:

Working Temperature: -20°C to +40°C

Standard: BS5733

DATASHEET

Item No.:B11261

Product Image

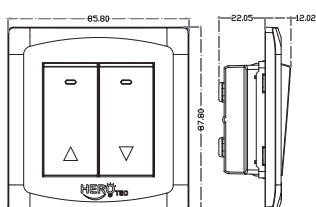

Name: up and down switch

Color: White,Black,Pearl,Gold, Gray,Beige,Copper,Sliver

Dimensions: L:85.8mm W:87.8mm H:34.07mm

Socket poles: Double poles

Current Rating:

Voltage: 220-250V~

Maximum Load:

Working Temperature: -20°C to +40°C

Standard: BS5733

DATASHEET

Item No.:B1101

Product Image

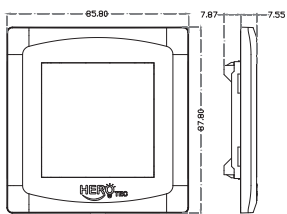
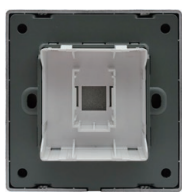

Name: 1 gang blank plate

Color: White,Black,Pearl,Gold, Gray,Beige,Copper,Sliver

Dimensions: L:85.8mm W:87.8mm H:15.42mm

Socket poles: Double poles

Current Rating:

Voltage: 220-250V~

Maximum Load:

Working Temperature: -20°C to +40°C

Standard:

DATASHEET

Item No.:B1102

Product Image

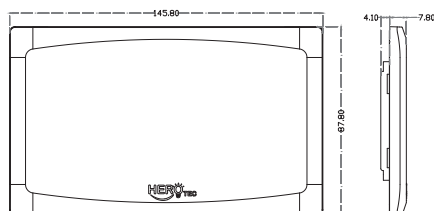

Name: 2 gang blank plate

Color: White,Black,Pearl,Gold, Gray,Beige,Copper,Sliver

Dimensions: L:145.8mm W:87.8mm H:15.42mm

Socket poles:

Current Rating:

Voltage: 220-250V~

Maximum Load:

Working Temperature: -20°C to +40°C

Standard:

| VARIOUS STYLE OCCASIONS



A LIVING ROOM



HOTEL



STUDY



DISCUSSION ROOM



RESTAURANT



AN ELECTRIC APPLIANCE

| Simplicity Fang Xian's Taste of Details

Classic streamline curvature

Multiple colors for you to choose from



- white
- pearl
- beige
- gold
- copper
- silver
- gray
- black

| Advantage characteristics



Medium plate



Arc corner



Modern stylish



Child lock protection



Integrated copper parts

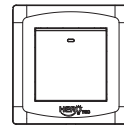

Minimal design

| Comfortable to touch

Innovative technology, safe load strong current shock Face and structure coexist



| Child safety door

Effectively prevent unipolar insertion
Prevent contact hazards caused by misinsertion

**| Flame retardant panel**

High temperature flame retardant PC, colorfast,
impact resistant and high temperature resistant

